

Modicon M580

The next generation controller
for PlantStruxure™ architecture



Schneider
Electric™



5 ways the Modicon M580 will revolutionize your process

Introducing Modicon M580

Built for truly open and efficient Ethernet networking

The controller of choice for the PlantStruxure architecture

Easy and flexible design that reduces your time-to-market

Migration strategies to protect your legacy investment

Dedicated solutions for your specific application

Customer testimonials

> Next page

>> Last page

<< First page

< Previous page

🏠 Main menu

🎥 Watch the video/animation

📖 Read more

⊕ Enlarge

⊗ Close

Clickable menu

Modicon.

It's a revolution. Every time.

1968

Modicon 084: the first Programmable Logic Controller (PLC) is introduced and revolutionizes the automation industry by replacing hard-wired, electro-mechanical relays with solid-state circuitry and relay ladder logic.

1996

Modicon Premium: pioneers a new class of PLC, the Programmable Automation Controller (PAC), and delivers high performance for large applications.

2003

Modicon Quantum: the first controller with embedded web server capabilities, breaks new ground in network communications.

2007

Modicon M340: the first all-in-one PAC. simplifies configuration, and operation. Its innovative batteryless design supports remote, unmanned applications.

2013

Modicon M580: Schneider Electric introduces the world's first ePAC, with Ethernet built right into its core.





Modicon M580, inspired by your need for efficiency

- Need timely and informed decisions?
- Want to minimize downtime?
- Looking for tangible energy savings?

The new Modicon M580 is more than just an improved PAC. It is the world's first ePAC, with native Ethernet built right into its core. It sets a new standard for ease of use and reliability to help you run a process that is both flexible and secure.

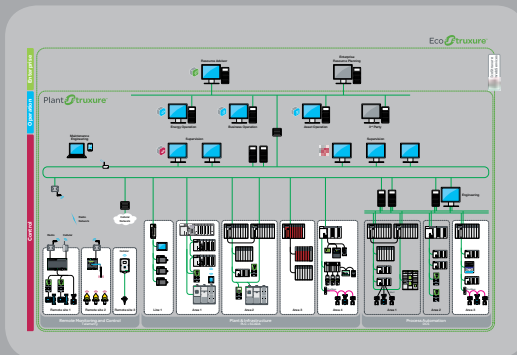

The world's first ePAC. So much more than a PLC.

The Modicon M580 ePAC embeds all the benefits of Ethernet right into the heart of your plant control architecture:

Transparency

- Unique and single communication flow for data from top to bottom
- No routing configuration needed thanks to standard IP routing within all systems
- Data-bridging solutions such as for HART data
- Direct high speed communication between CPU and communication modules



- Open architecture with direct Ethernet connection on backplane
- Natively deterministic and synchronized with PAC tasks
- Full compliance based on ODVA and FDT/DTM for fieldbus masters



The world's first ePAC. So much more than a PLC.

Integrated Ethernet infrastructure

- Easy cabling with third Ethernet port available on all Ethernet modules
- Embedded wi-fi communications
- Embedded fibre optic converter
- Embedded switches functions

Openness

- Open to third party devices supporting Modbus TCP and Ethernet IP
- Backplane open for easy design of X80 expert modules
- Standard FDT/DTM combined with Ethernet simplifies management of third party devices

The world's first ePAC. So much more than a PLC.

Performance:

- 1Gbps Ethernet interface in CPU
- Backplane performance 100Mbps
- One dedicated microprocessor core for communication to minimize jitter
- Communication determinism thanks to enhanced Ethernet management
- Latest generation ARM (Advanced RISC Machines) dual-core processor

Cybersecurity:

- Embedded security features in compliance with IEC62443 standards
- Achilles Level 2 certification
- Encrypted password access
- Strict supervision of firmware and software integrity
- Memory with error correction code



More flexibility in design



Use Ethernet as an I/O network

- Flexibility in architecture design through copper, fibre, or wireless connections
- Simple daisy chain loop topology with no external switches (including fibre)
- Ring architecture provides additional network resilience

Mix core control devices on Ethernet

- Flexible topology allows simple integration of core control devices
- Ability to mix remote I/O, distributed I/O, and other devices on the same Ethernet field network with complete software integration
- Transparent access to data through Ethernet backbone

Easily connect to fieldbus and other networks

- Simple HMI integration via third port on remote I/O head
- Interface to other popular fieldbus and device networks, including AS-Interface, Modbus, Profibus, and HART

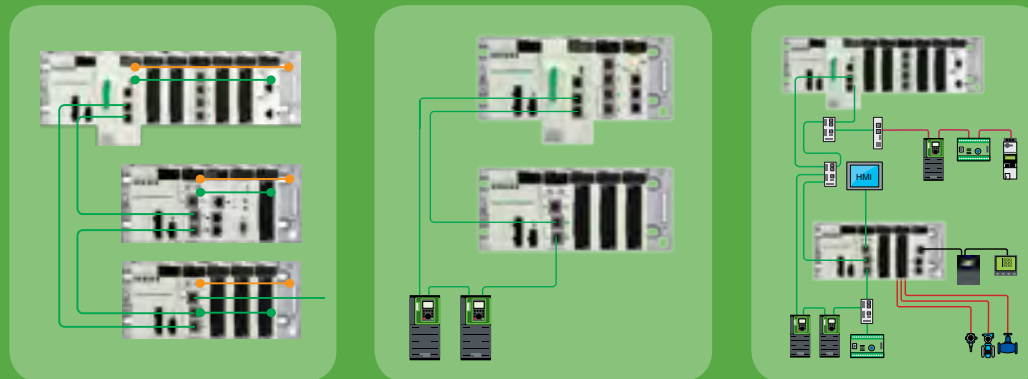

More agility for your operations

Perform live application updates without pausing the process

- Add or remove discrete and analogue I/O modules (not time stamped)
- Add new RIO drops
- Modify channel configuration parameters
- Reconfigure modules automatically on hotswap
- Apply changes to configuration on the fly (CCOTF)

Access dynamic information via Ethernet

- Get information online via integrated web server access
- Perform simple remote and mobile diagnostics
- Manage SCADA screens via HMI
- Remotely access HMI screens

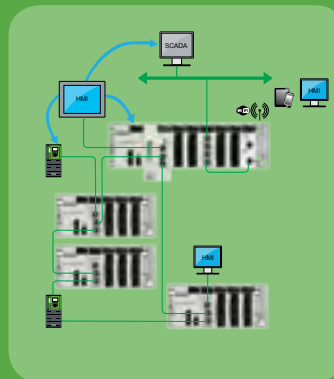
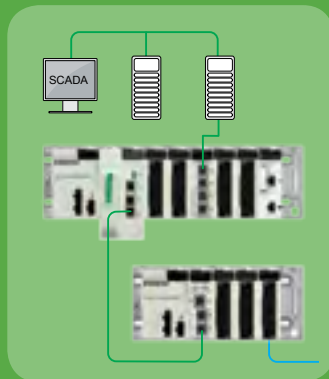

PlantStruxure, your integrated and collaborative architecture

The Modicon M580 is the new recommended controller for PlantStruxure, Schneider Electric's collaborative and integrated automation architecture for industrial and infrastructure customers.

PlantStruxure brings together our Telemetry, PLC/SCADA, and DCS offerings with complete life cycle services to help make your operations more efficient.

From initial design to modernization, PlantStruxure transparently connects the control, operation, and enterprise levels of your business.

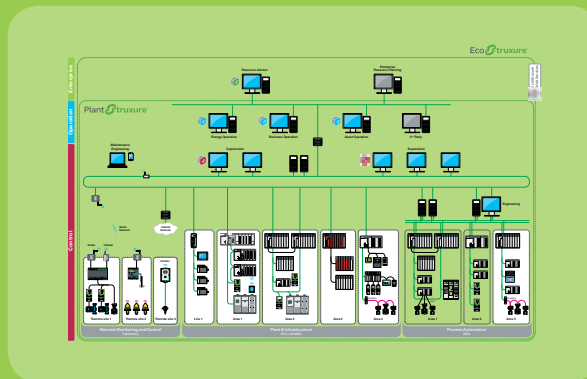

Modicon M580, the controller of choice for PlantStruxure

Unity Pro software

Unity Pro is a unique software platform that increases design productivity and performance of your Modicon M580, M340, Momentum, Premium, and Quantum applications.

You can migrate your developed programming to Modicon M580 without rewriting your application.

Unity Pro conversion tools provide a smooth transition from legacy PLCs to state-of-the-art PACs, using functions such as standardized objects, libraries, and structured versions of data, as well as predefined diagnostic parameters of common X80 I/O modules. Best of all, Unity Pro lets you maintain and update your installation without stopping production (CCOTF).

OPC Factory Server software

The OPC Factory Server software enables you to benefit from more openness and a simplified interface between your SCADA and PACs.

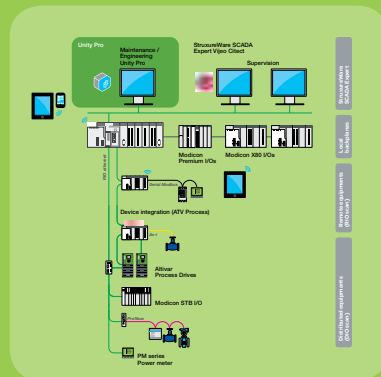

Modicon M580, the controller of choice for PlantStruxure

Native SCADA integration, for more process transparency

The Modicon M580 integrates seamlessly with the best-in-class SCADA software, StruxureWare SCADA Expert Vijeo Citect. The result is a comprehensive solution that optimizes your process and reduces downtime.

StruxureWare SCADA Expert Vijeo Citect provides operators with direct access to the Modicon M580 application without the need to use Unity Pro. This enables a quick and easy overview of the status of the controller and linked devices, as well as more detailed information for in-depth troubleshooting. This close integration gives operators the ability to handle process disturbances efficiently and without delay.

Using the new Modicon M580 and StruxureWare SCADA Expert Vijeo Citect together also means:

- Better response times and optimized configuration for high speed communication
- Online modification or configuration of the Modicon M580 all within the SCADA system
- Controller alarm viewer directly within the SCADA interface
- Visibility to all process data and field devices from SCADA level

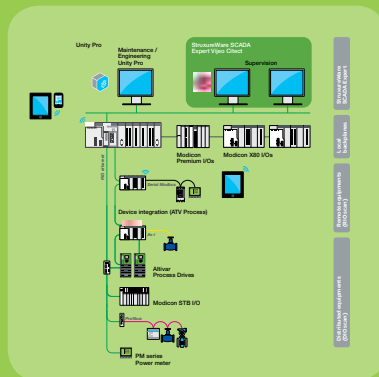

Seamless integration of drives, for easy energy monitoring

The combination of our new Modicon M580 and Altivar Process variable speed drives* results in a truly productive, efficient, and energy-aware process. The new energy measurement functions embedded in Altivar Process enable you to easily monitor the energy performance of your more demanding assets (motors, pumps, fans), helping to optimize the overall energy efficiency of your process.

With dedicated object libraries, embedded commissioning tools, and predictive/preventive diagnostic features, the Modicon M580 simplifies your automation assets configuration and maintenance. At the same time, Altivar Process drives provide dual Ethernet daisy chain ports or high availability. Additionally, they integrate DTM for Unity Pro FDT container, enabling you to easily access your equipment's data without developing a special user interface.

* Available in Q2 2014

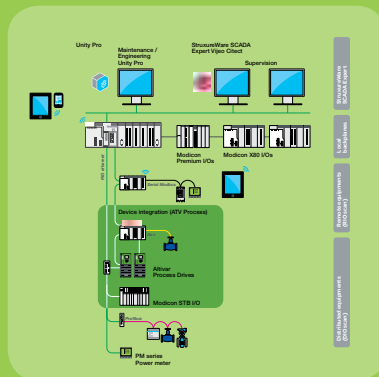

Protect your hardware investment

Smart migration solutions

- Standardize on the Modicon family with common X80 modules
- Reduce training and maintenance costs
- Keep your existing Modicon Premium I/O and wiring
- Upgrade smoothly with migration paths for both hardware and software
- Adjust your process quickly to changing market demands with dedicated service ports and migration services

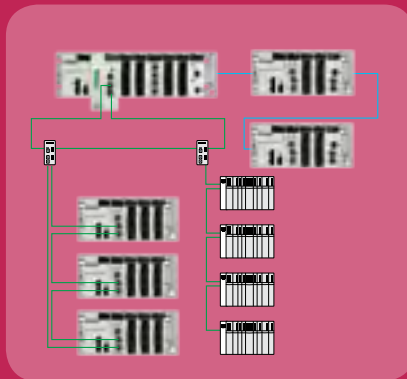



Best-in-class controller for your application



Best-in-class controller for your application

Water & Wastewater

Network & pumping management

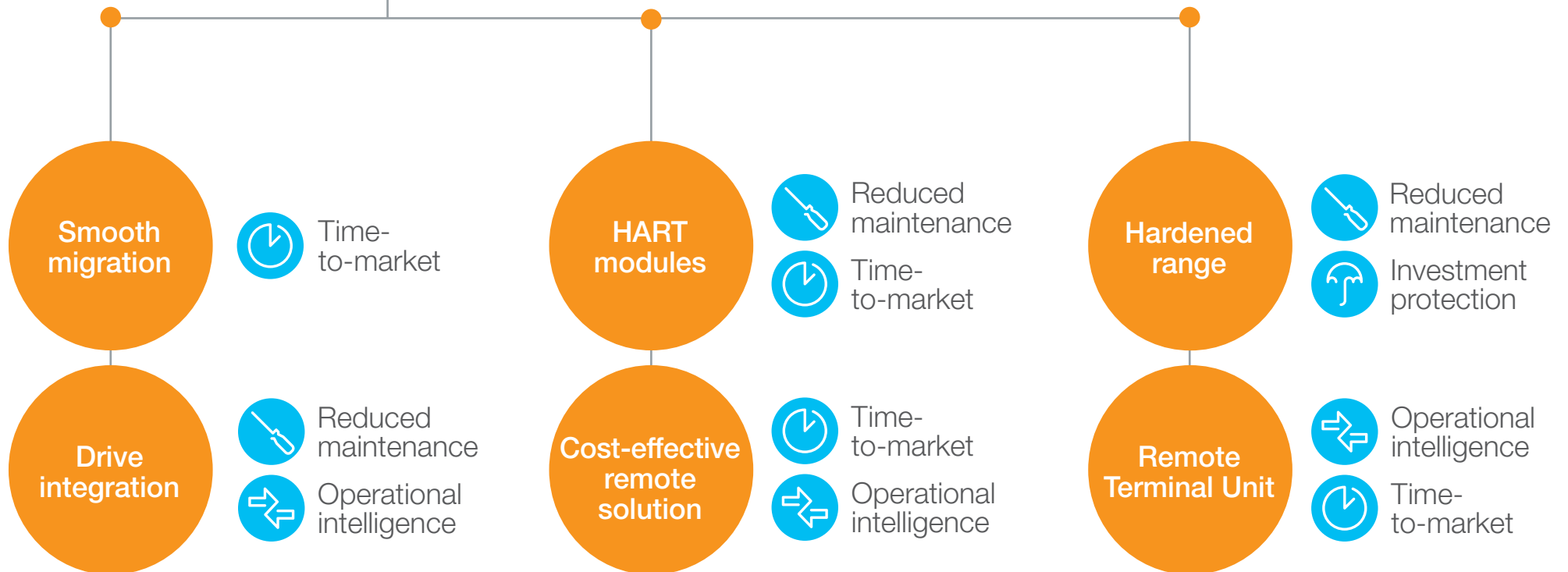



Best-in-class controller for your application

Food & Beverage

Confectionery

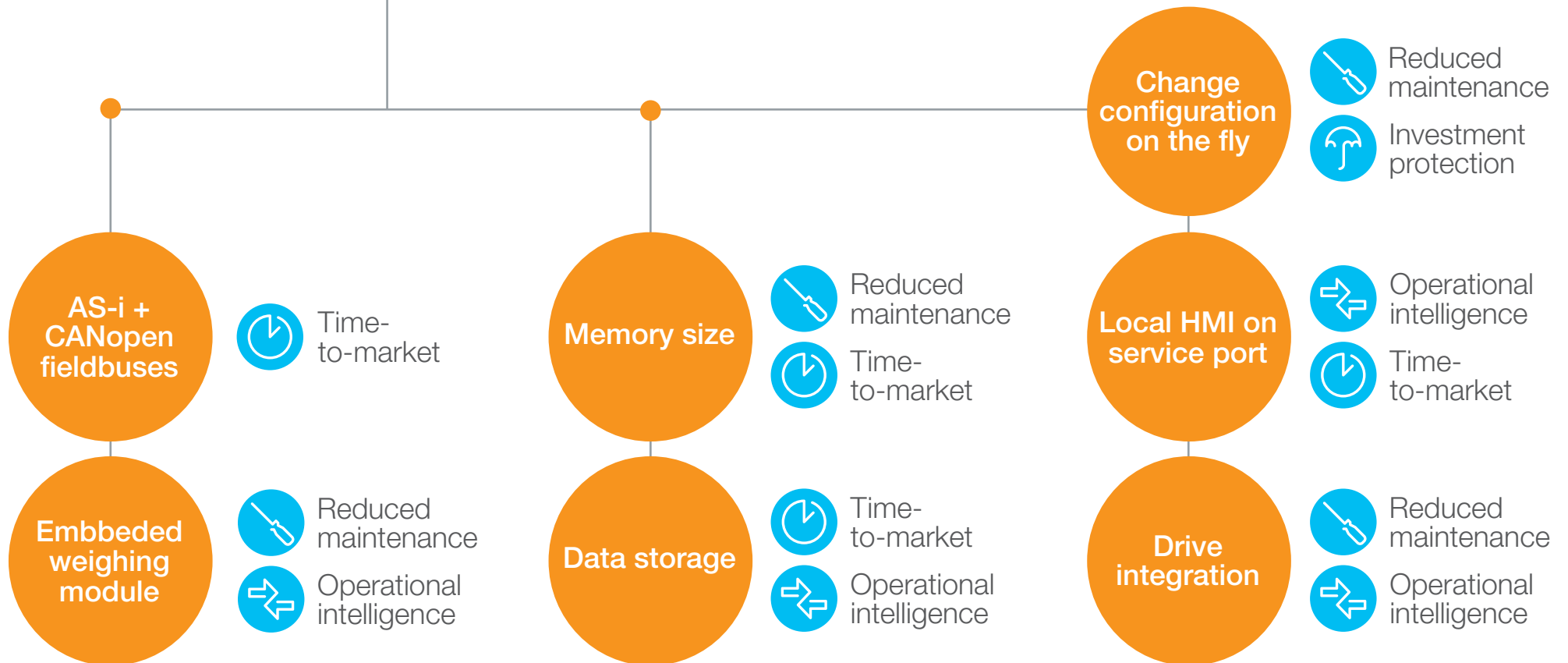



Best-in-class controller for your application

● Mining, Minerals & Metals

Cement
Material handling

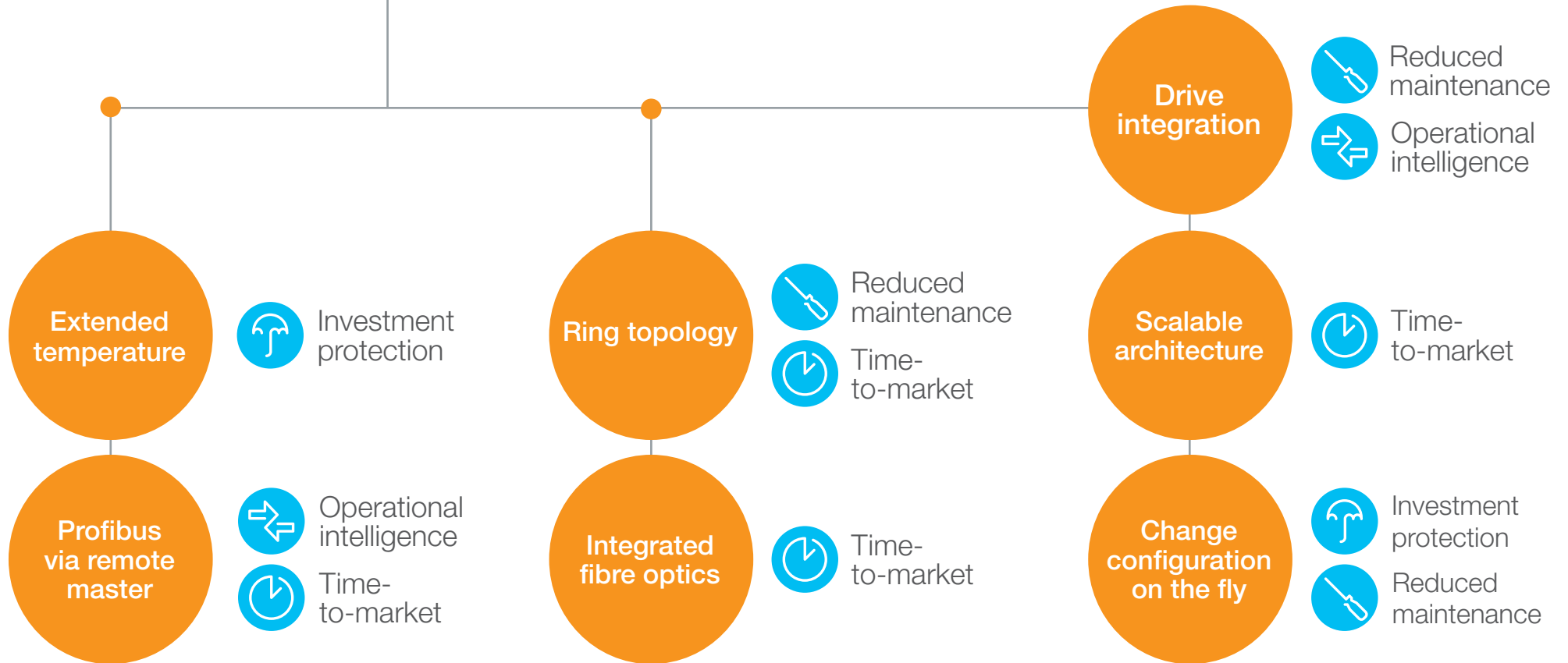



Best-in-class controller for your application

Hydroelectric Energy

Medium size plant management

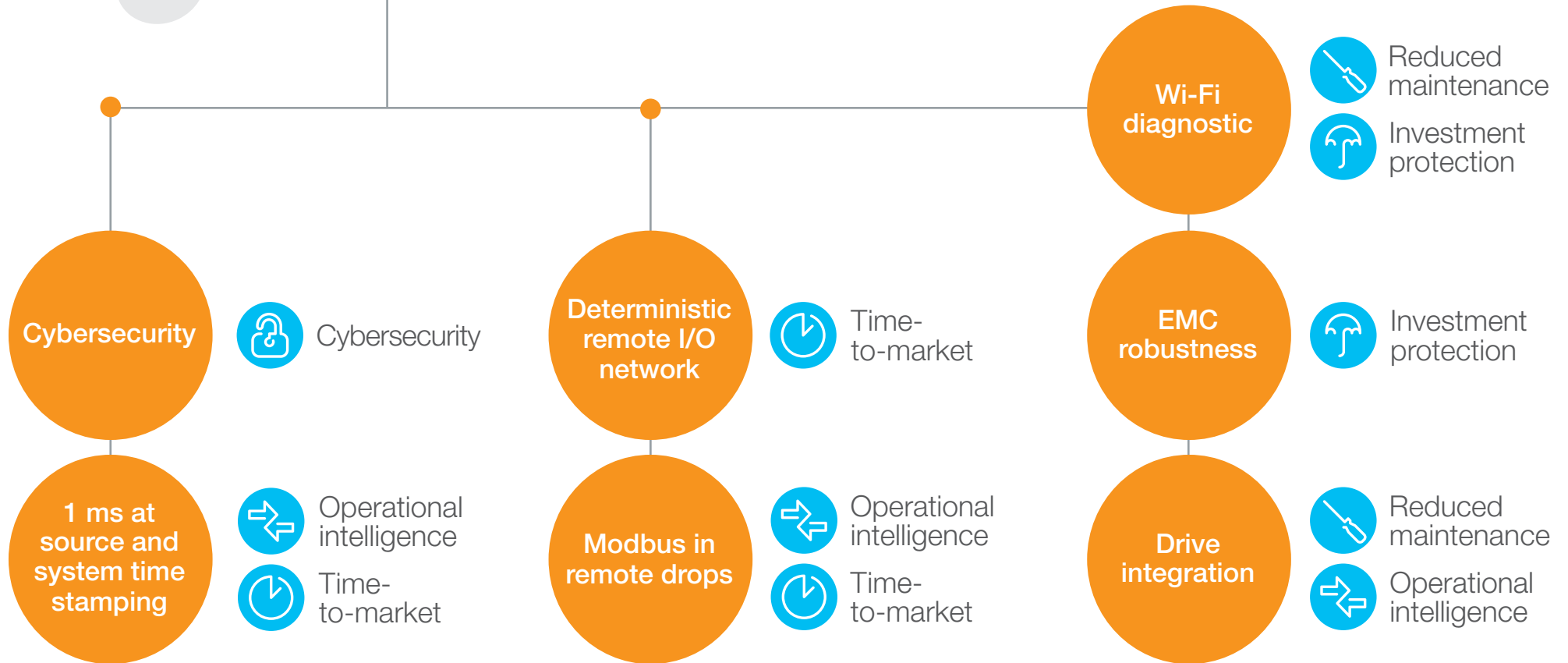



Best-in-class controller for your application

Oil & Gas Pipeline management*

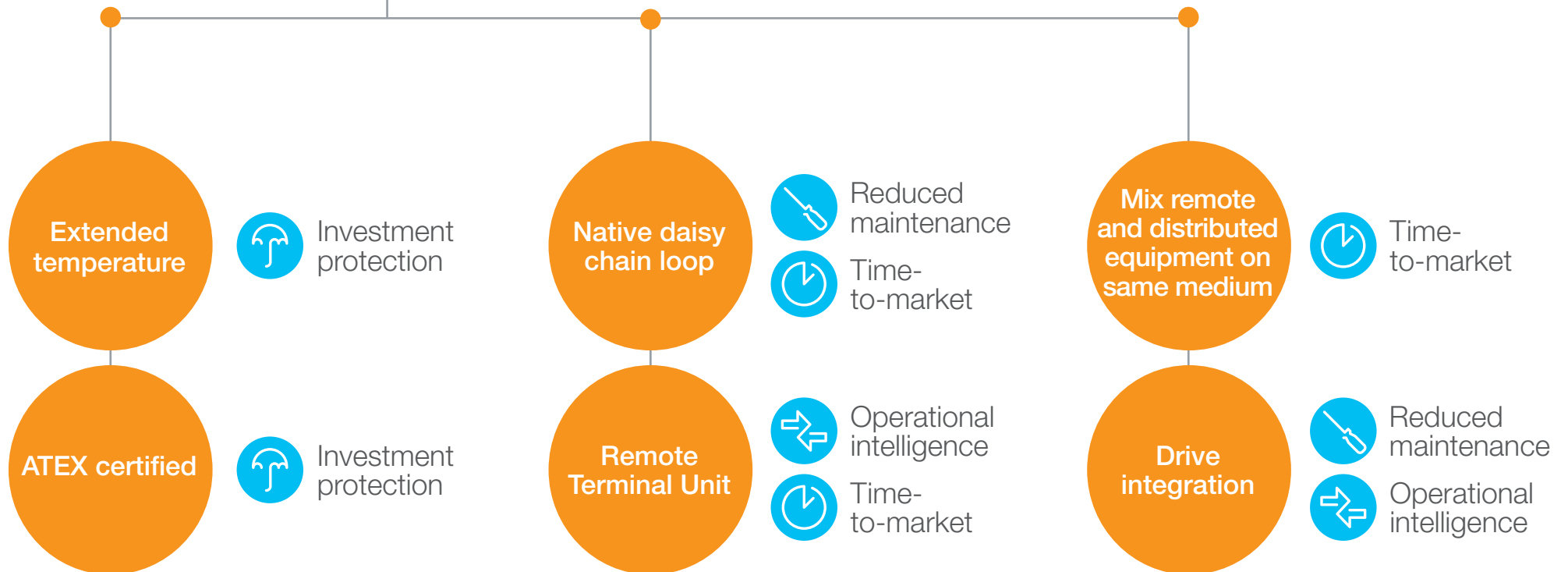

* Safety in 2015, HSBY in 2016

Customer testimonials



“ I think that Modicon M580 will revolutionize our IAS architectures (Integrated Automation System on ships).

Barillec – France

“ Modicon M580 is really the best controller I have ever seen.

BENTEC O&G – Germany

“ I am impressed and pleased with Schneider Electric’s vision of the future.

Columbia River Carbonates – USA

“ Modicon M580 is beyond my imagination with the incredible level of flexibility not only for the network architecture, but also the diagnostics and maintenance.

FoShan DeXun Water Co., Ltd - China

Make the most of your energySM

Schneider Electric Industries SAS

Head Office

35, rue Joseph Monier - CS30323

F92505 Rueil-Malmaison Cedex

FRANCE

©2013 Schneider Electric. All Rights Reserved. All trademarks are owned by Schneider Electric Industries SAS or its affiliated companies. 998-1228459_GMA-GB

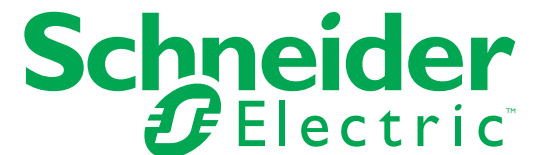

Appendix



Plant EcoStruxure™

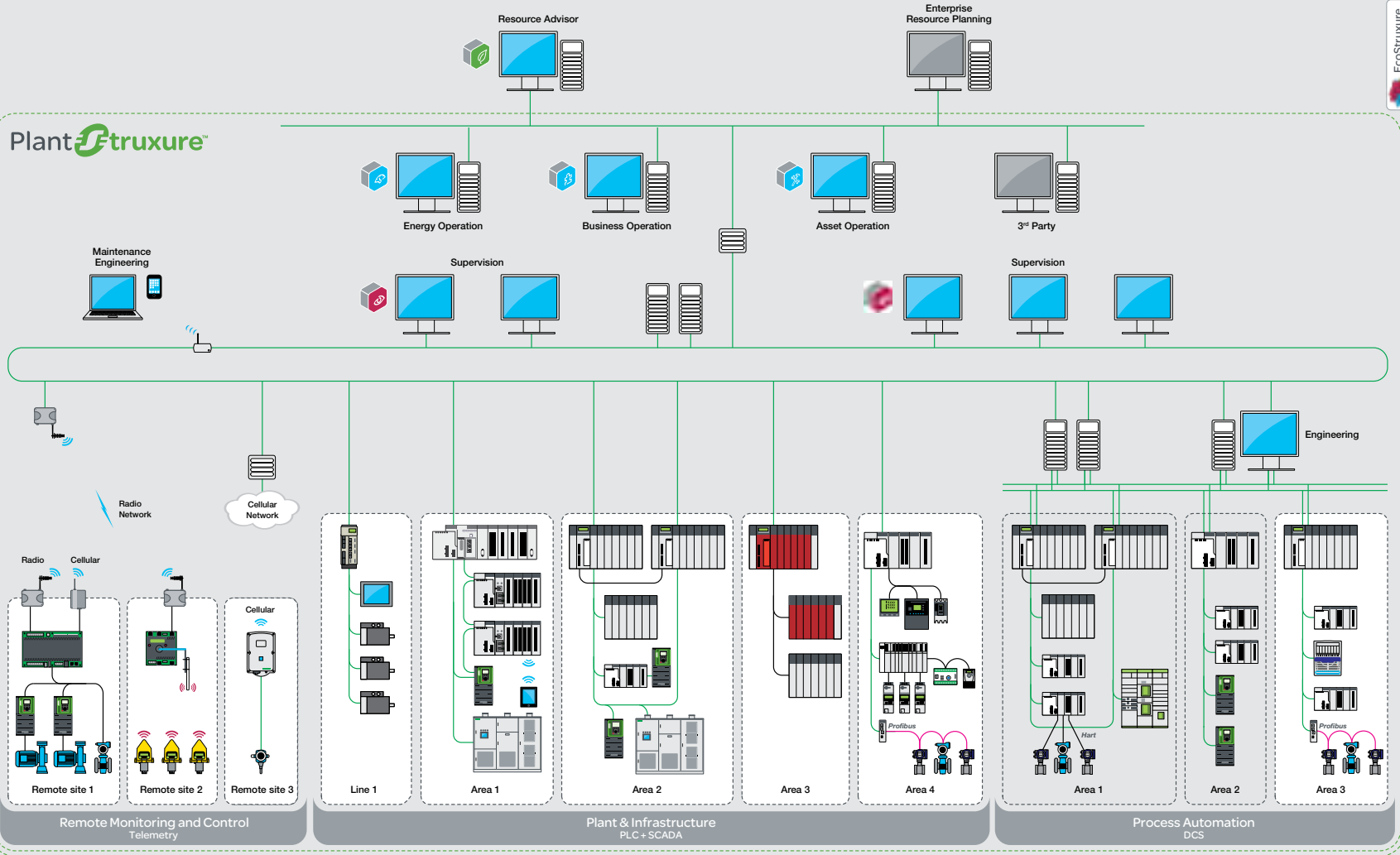

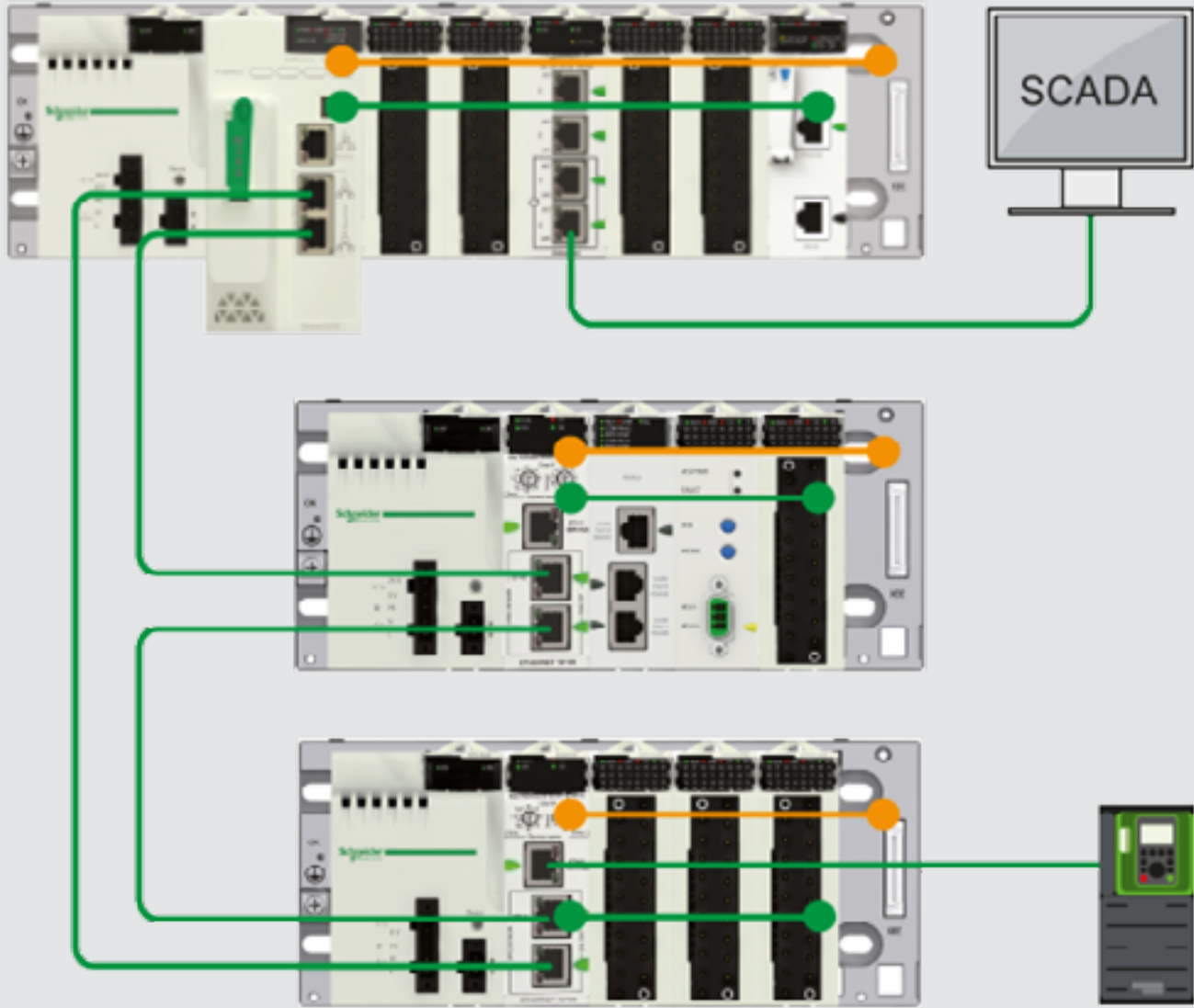

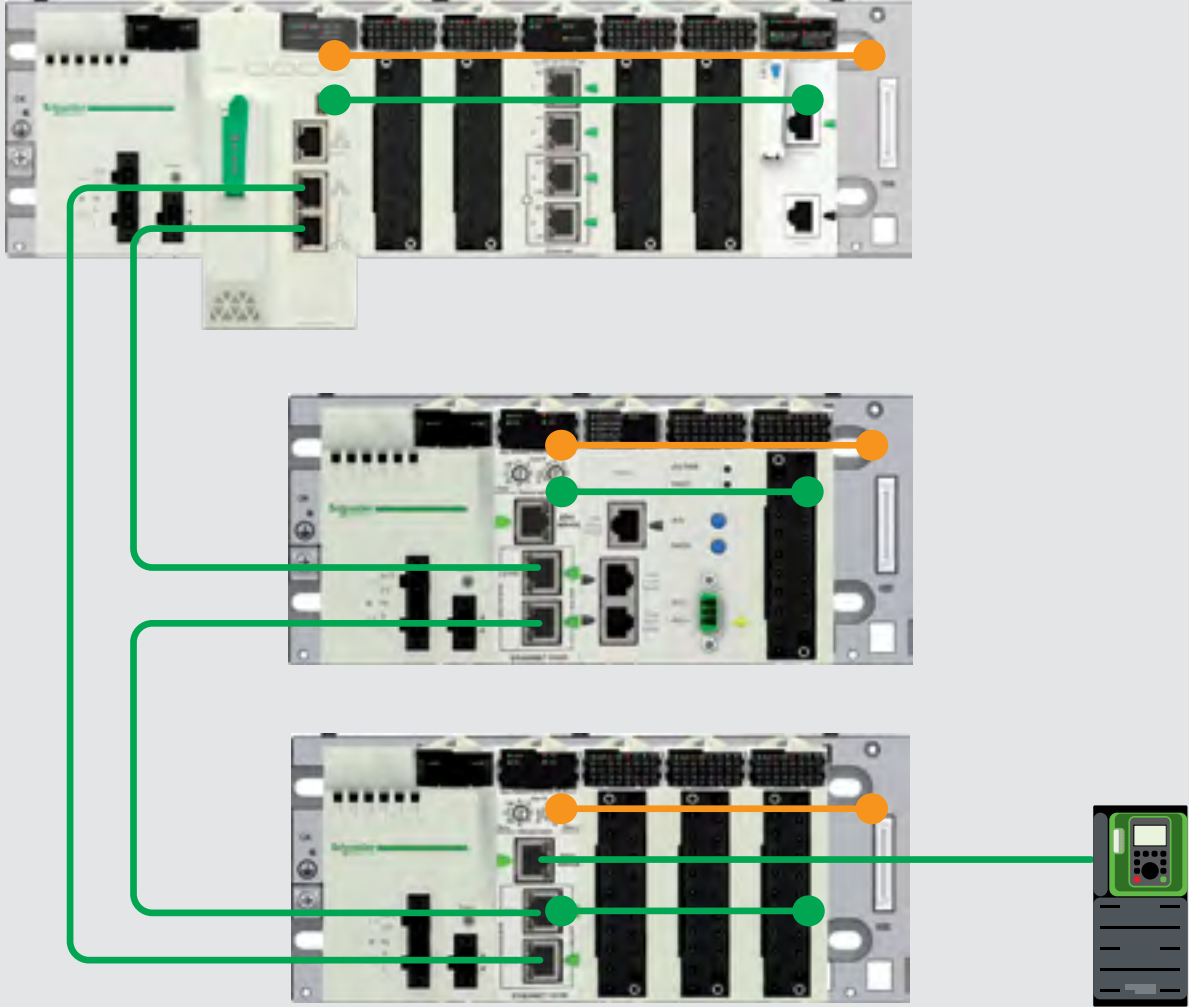

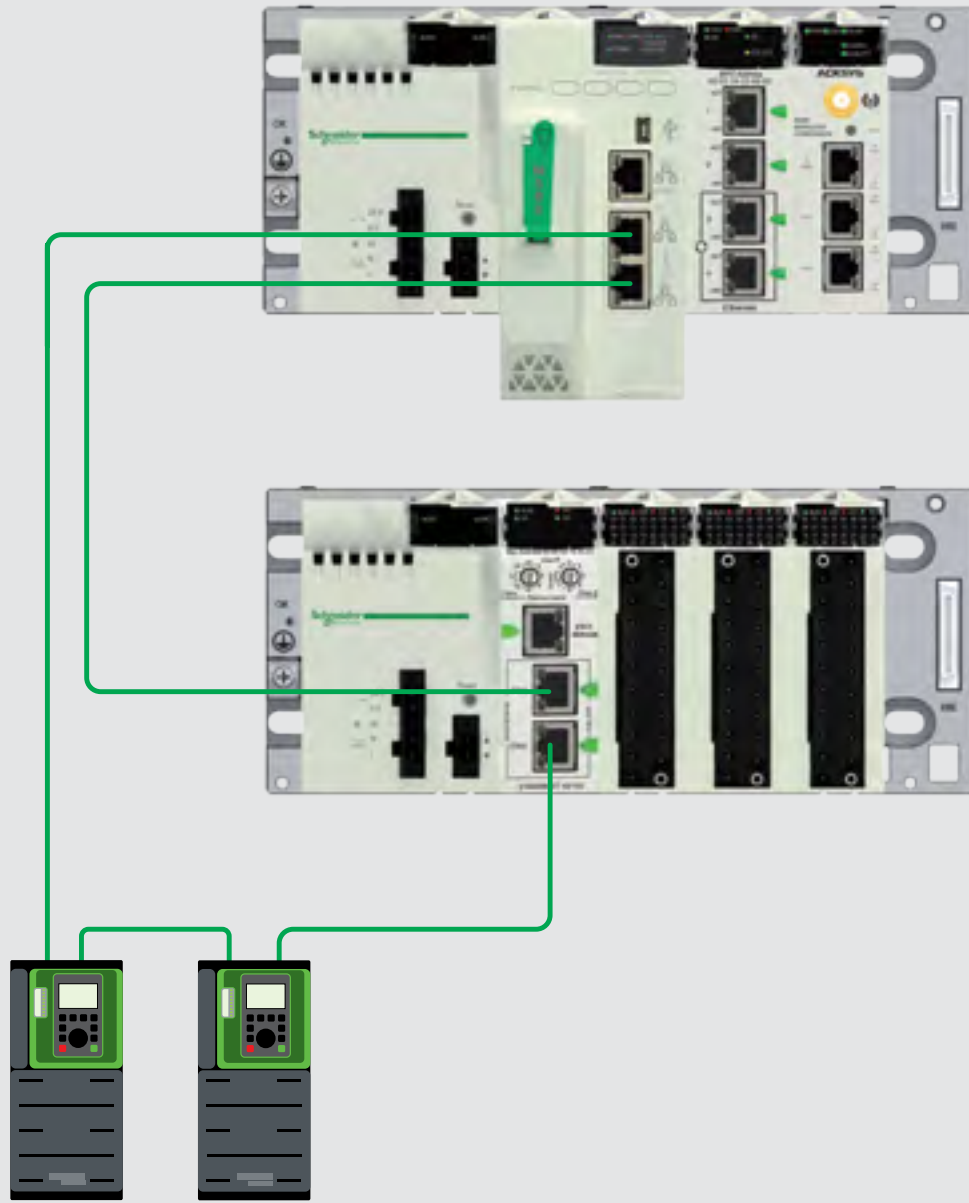

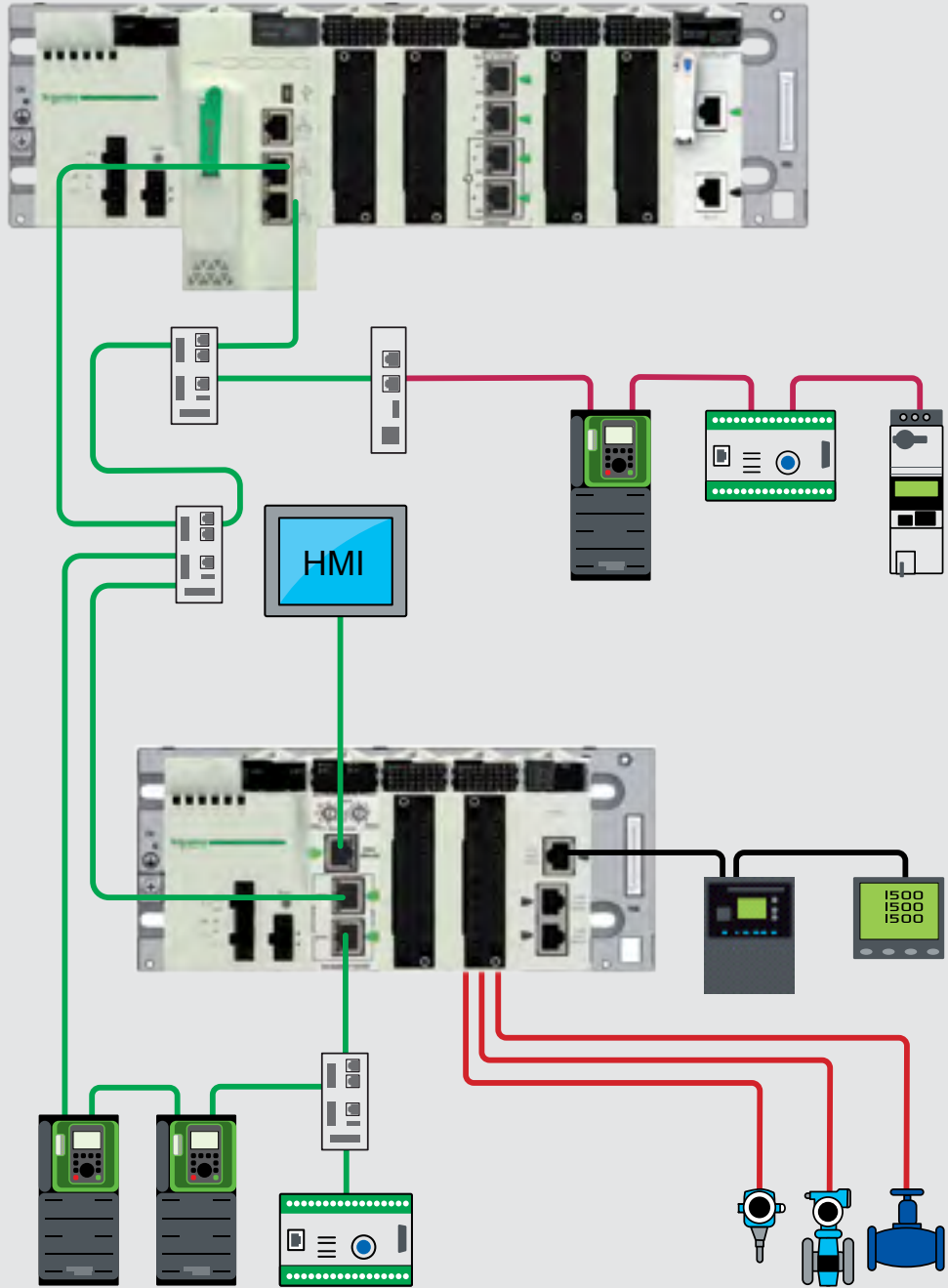

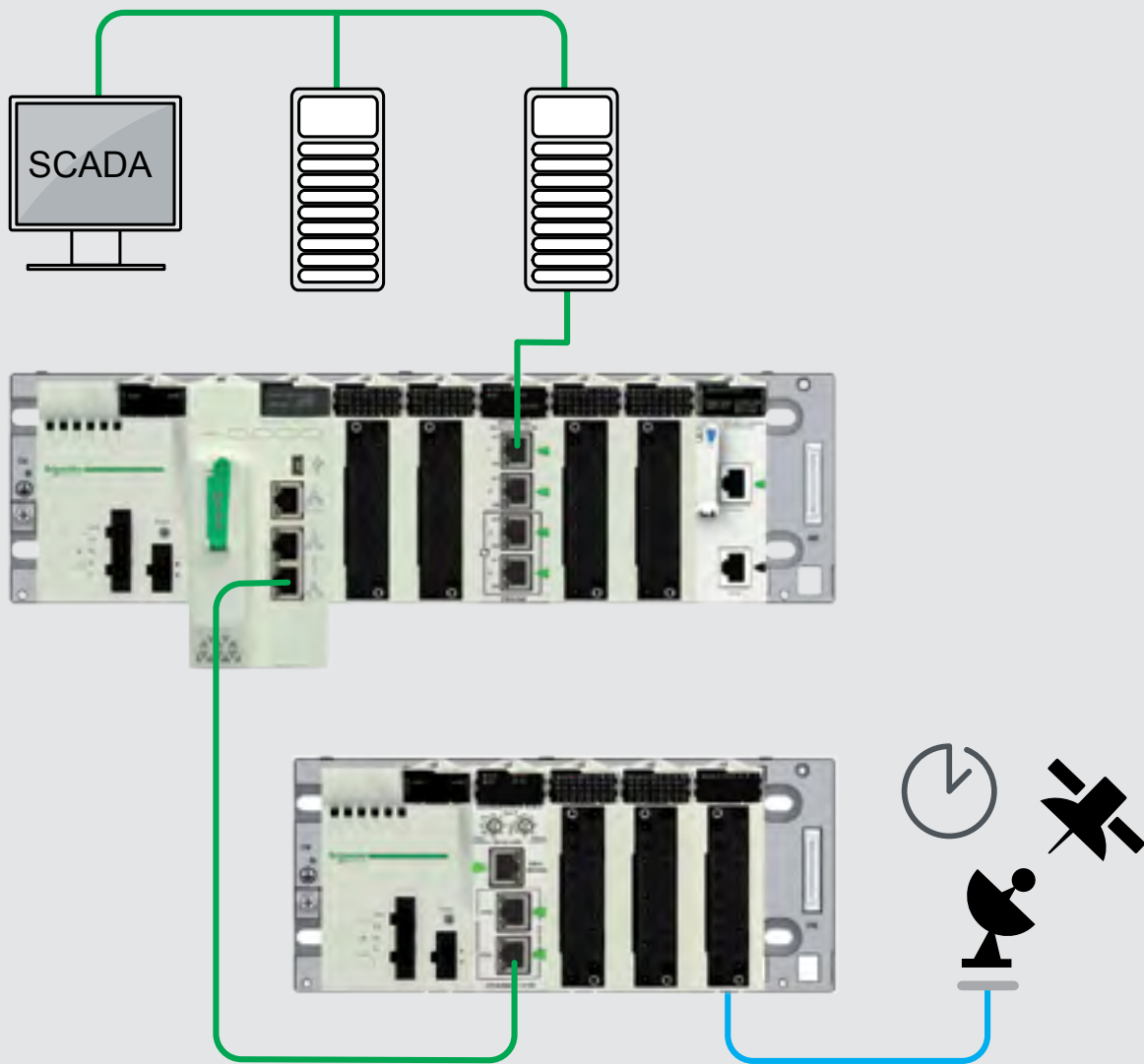

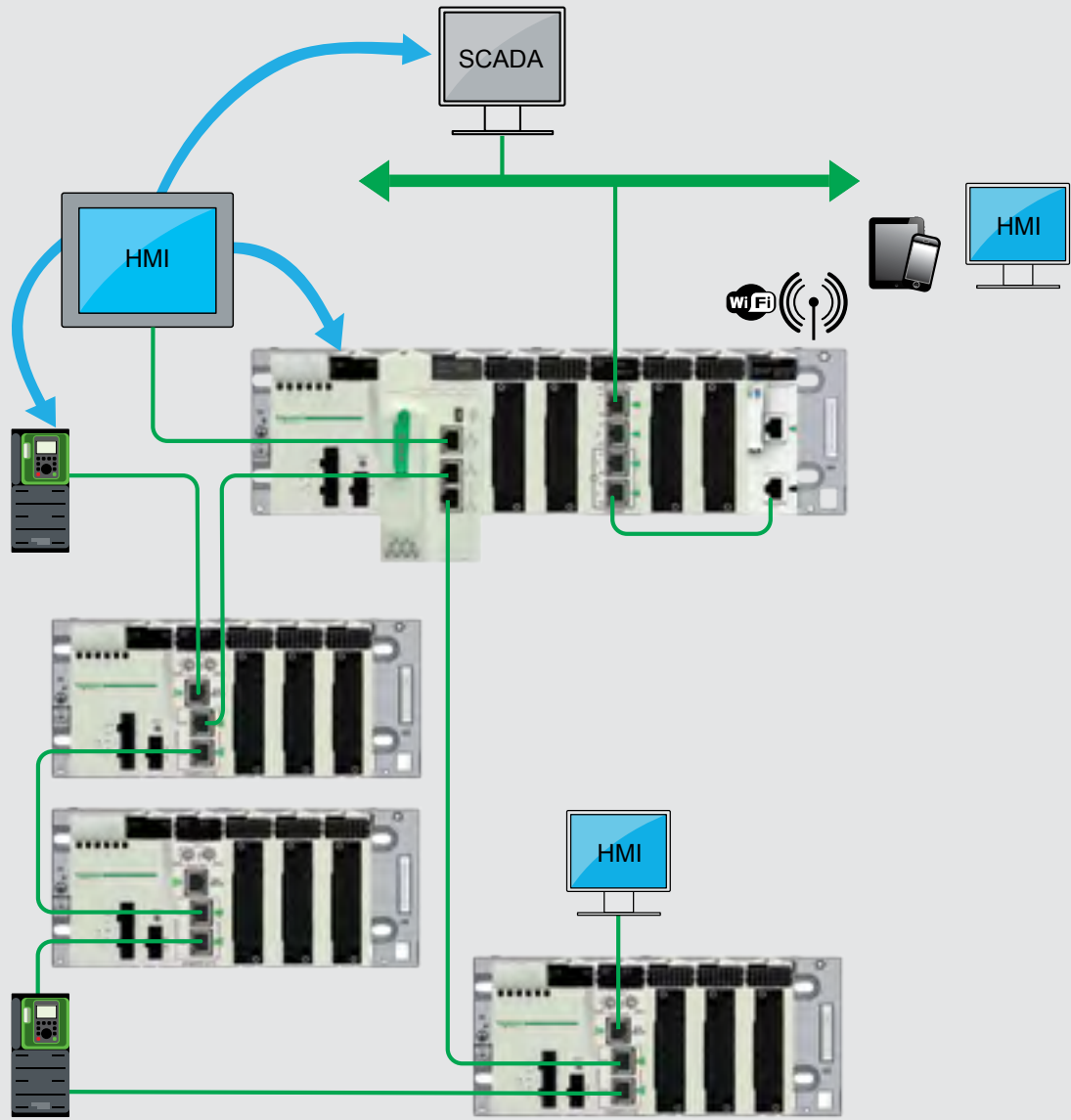

Enterprise

Operation

Control

Plant EcoStruxure™

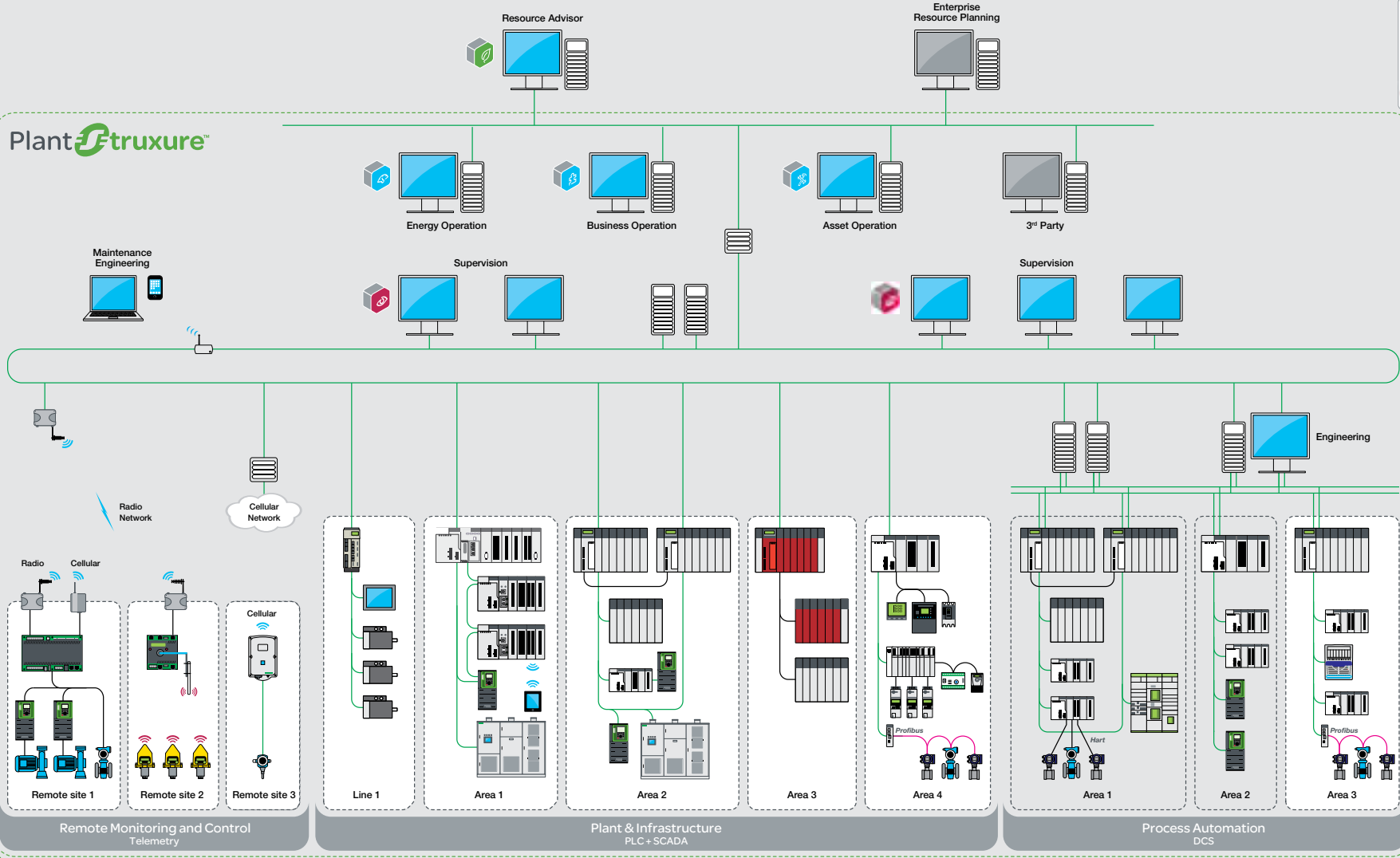

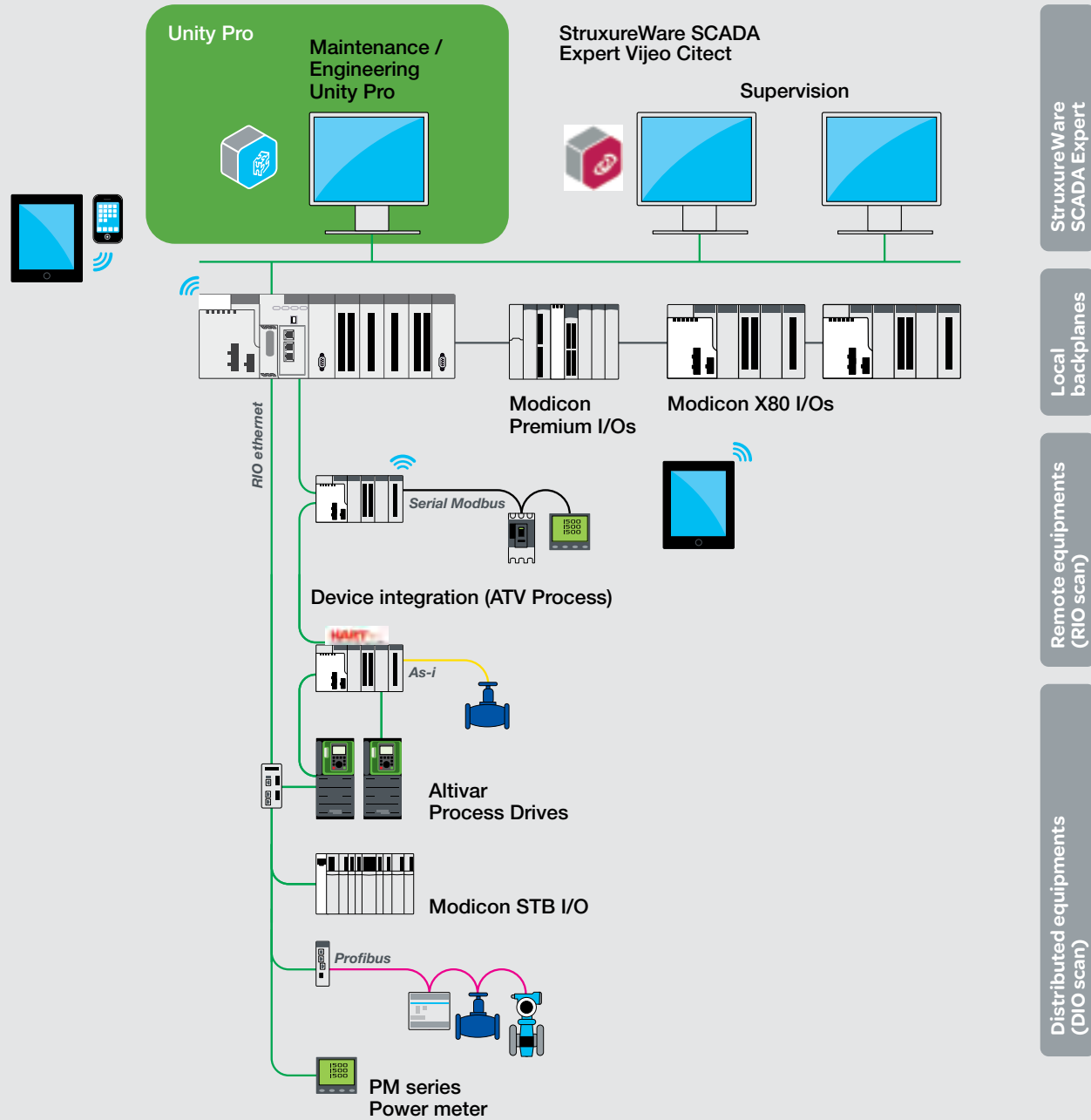

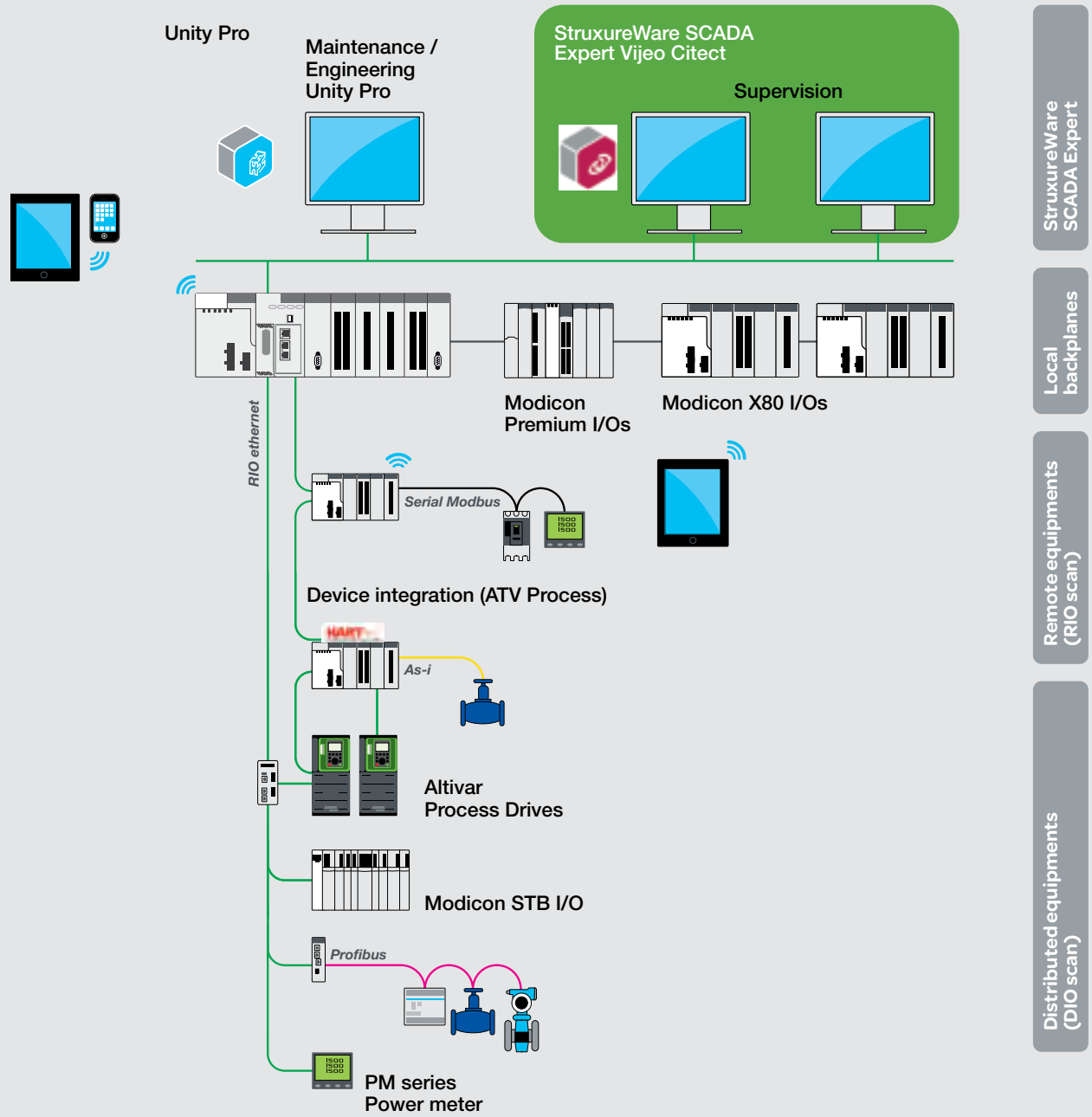

SCADA Expert
Vijeo Citect

21-11-2013	11:06:55 AM	MyQuantum_E800CivStation0	OK
21-11-2013	11:06:55 AM	MyQuantum_E800CivStation1	OK
21-11-2013	11:06:55 AM	MyQuantum_E800CivStation2	OK

M580 Standard Web

Home | Diagnostic

Home

- Home
- Status Summary
- Performance
- Port Statistics
- Connected Devices
- IO Scanner
- Messaging
- Services
- Cell
- API
- Redundancy
- System
- Alarm Views

Status Summary

Service Status

Version Info

E800 Version
 Web Server Version
 Web UI Version - **V01.00.0004**
 CPU Version

CPU Summary

Model
 Size
 Core Type
 Location

Page 1 of 1

2013-11-21 11:07:00 AM

